



alumawall

Stackable sleeper

An extruded aluminium stackable sleeper designed to be used under steel panel fences or as a retaining wall sleeper.

- › Sturdy aluminium design with high quality powder coat finish
- › Fits neatly into 'C' section posts of common steel panel fencing brands
- › Perfect for preventing weeds or debris from protruding through gaps in fence
- › Can also be used to level or increase the base height of the fence
- › 2385mm long x 150mm high x 50mm wide – check your 'C' section posts to ensure correct fitting
- › Easy width adjustment – simply cut to desired width
- › Specially designed heavy duty post available for retaining wall installations
- › Sleeper comes with two free black nylon end caps

Easily stackable!

1 SLEEPER
150mm high

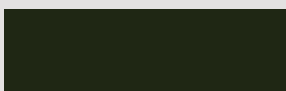

2 SLEEPERS
280mm high

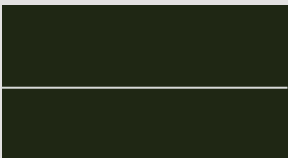

3 SLEEPERS
410mm high



4 SLEEPERS
540mm high

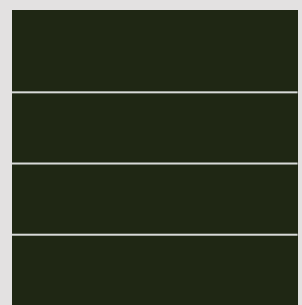

Primrose **AWALL-2385-P** Paperbark **AWALL-2385-PB** Woodland Grey **AWALL-2385-G** Monument **AWALL-2385-MN**



- Primrose
GD037A
- Paperbark
GU114A
- Woodland grey
GL205A
- Monument
GL229A



alumawall

- Retaining wall system -

Stackable sleeper

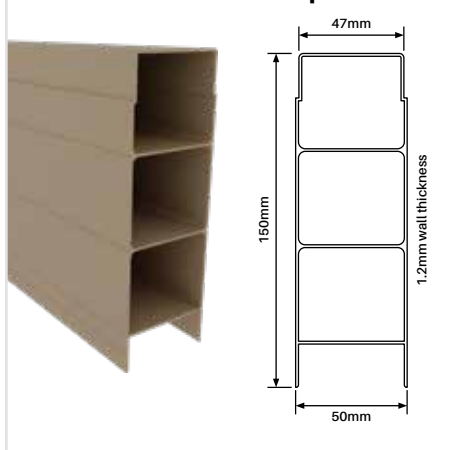

Retaining wall post

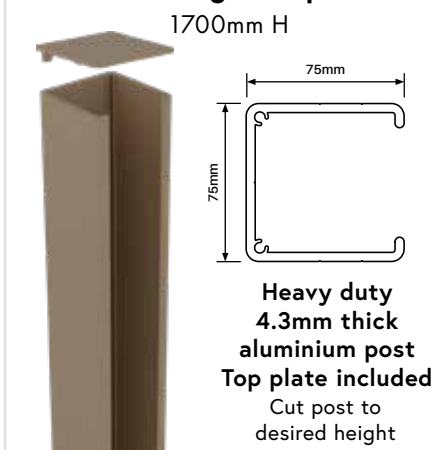



Top plate

OPTIONAL EXTRA. POSTS COME WITH TOP PLATE



- Only required if cutting down posts to shorter lengths & extra top plates are required
- Available in Woodland Grey, Monument, Primrose & Paperbark

Order code: AWALL-TP-G/MN/P/PB

	POST CODES:
 Primrose GD037A	AWALL-1700-1W-P
 Paperbark GU114A	AWALL-1700-1W-PB
 Woodland grey GL205A	AWALL-1700-1W-G
 Monument GL229A	AWALL-1700-1W-MN

*Post includes top plate

Easily adaptable for 1 way, 2 way and 90° corner configurations

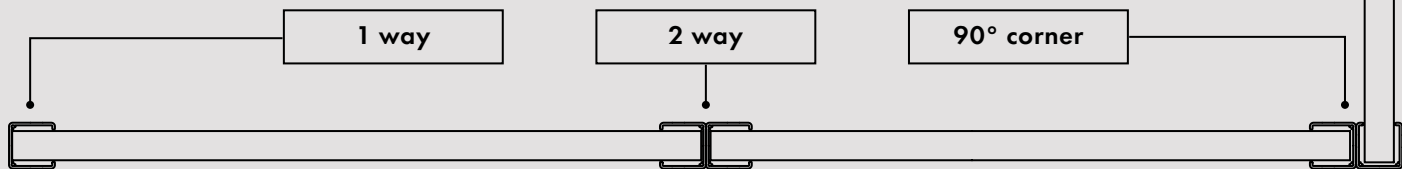

To join posts for 2 way or corner configurations, simply screw together using 15mm x 10G self tapping screws

Available in woodland grey, monument, primrose & paperbark



IMPORTANT!
Engineering must be considered.
Contact us for relevant documents